

ALLES JERSEY

KLEIDER & *Shirts*

Alle Rechte bei ©Edition Michael Fischer GmbH, Igling

LOLO #2 HOODIE

Die Naht- und Saumzugaben sind nicht enthalten.

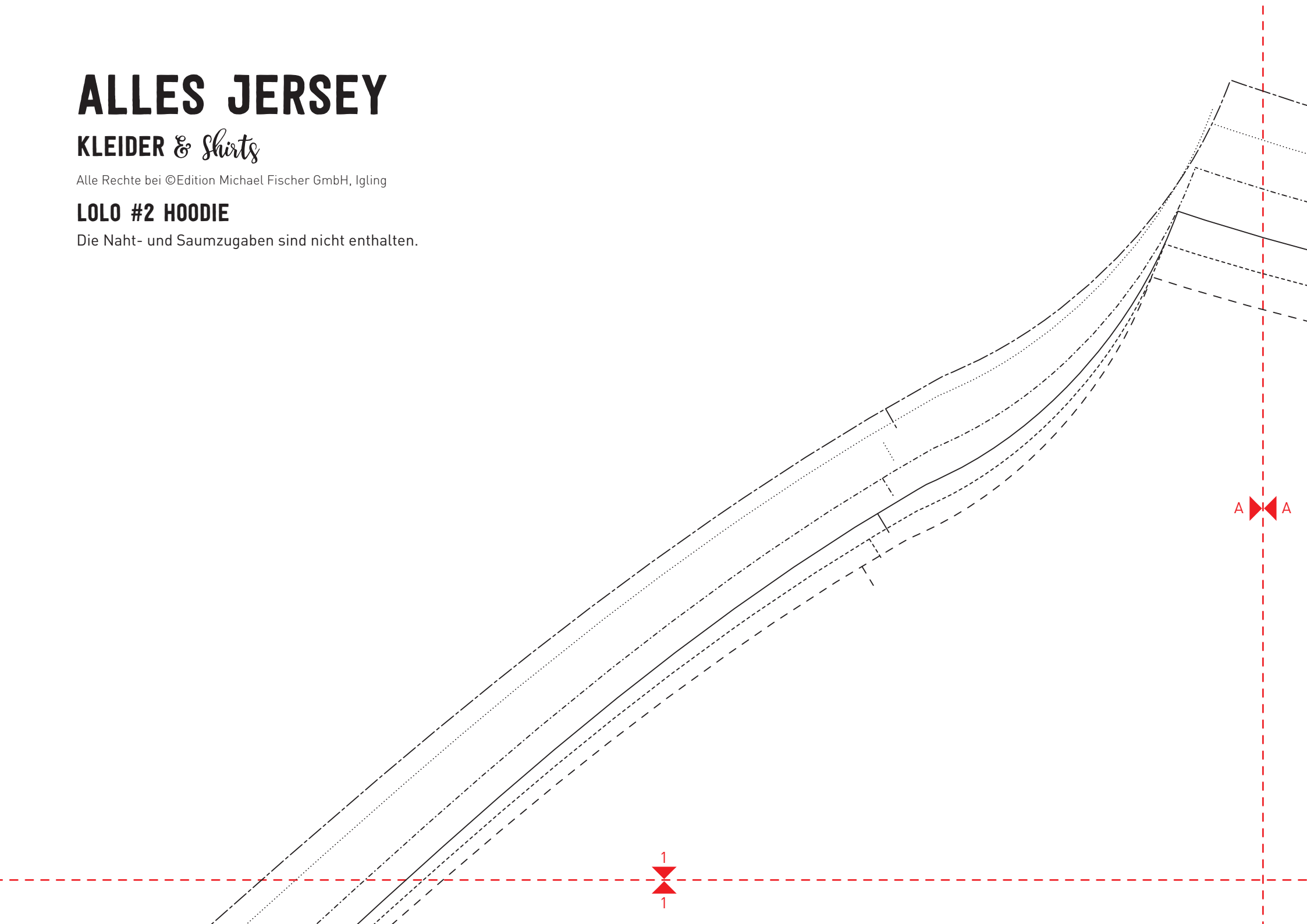

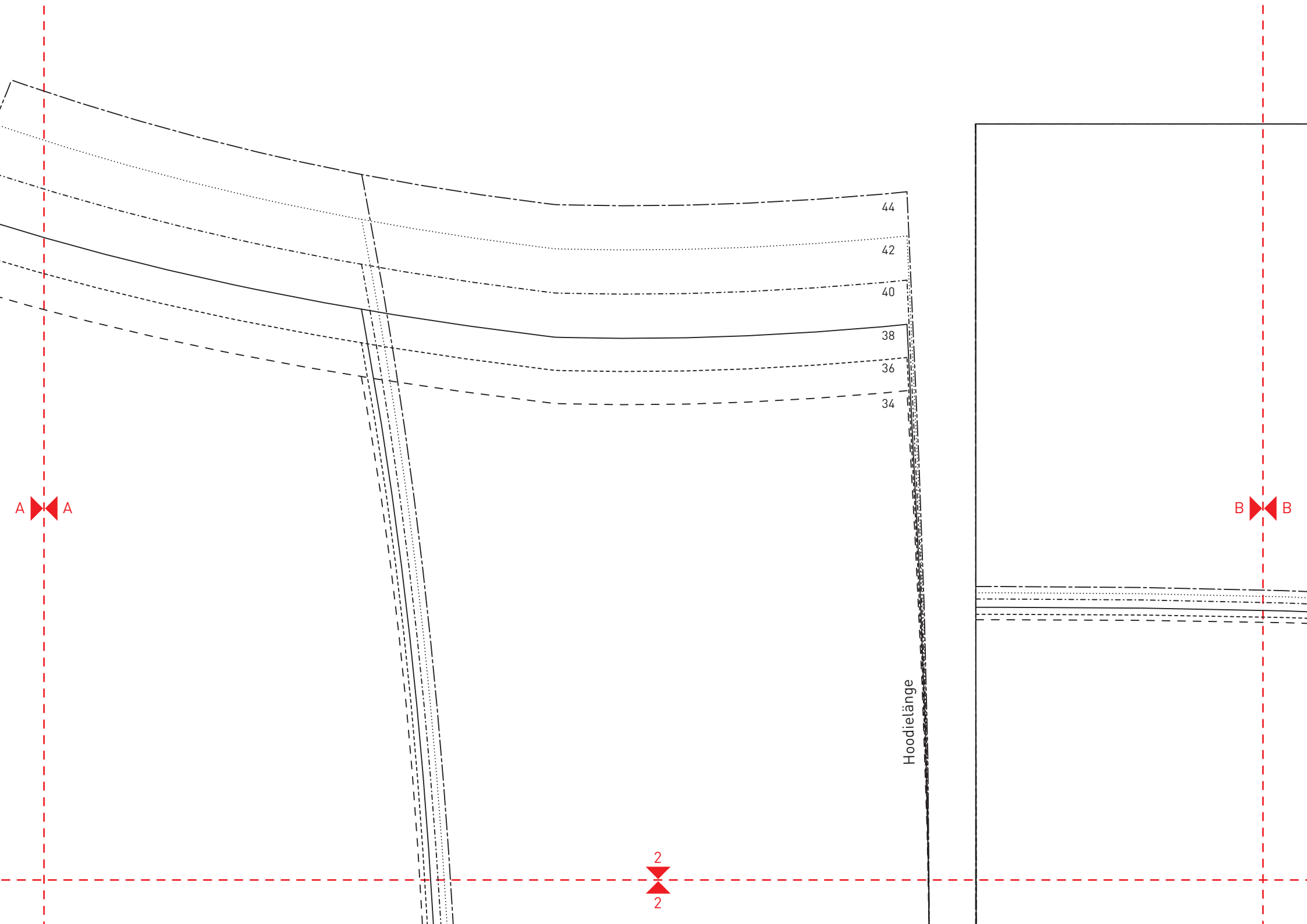

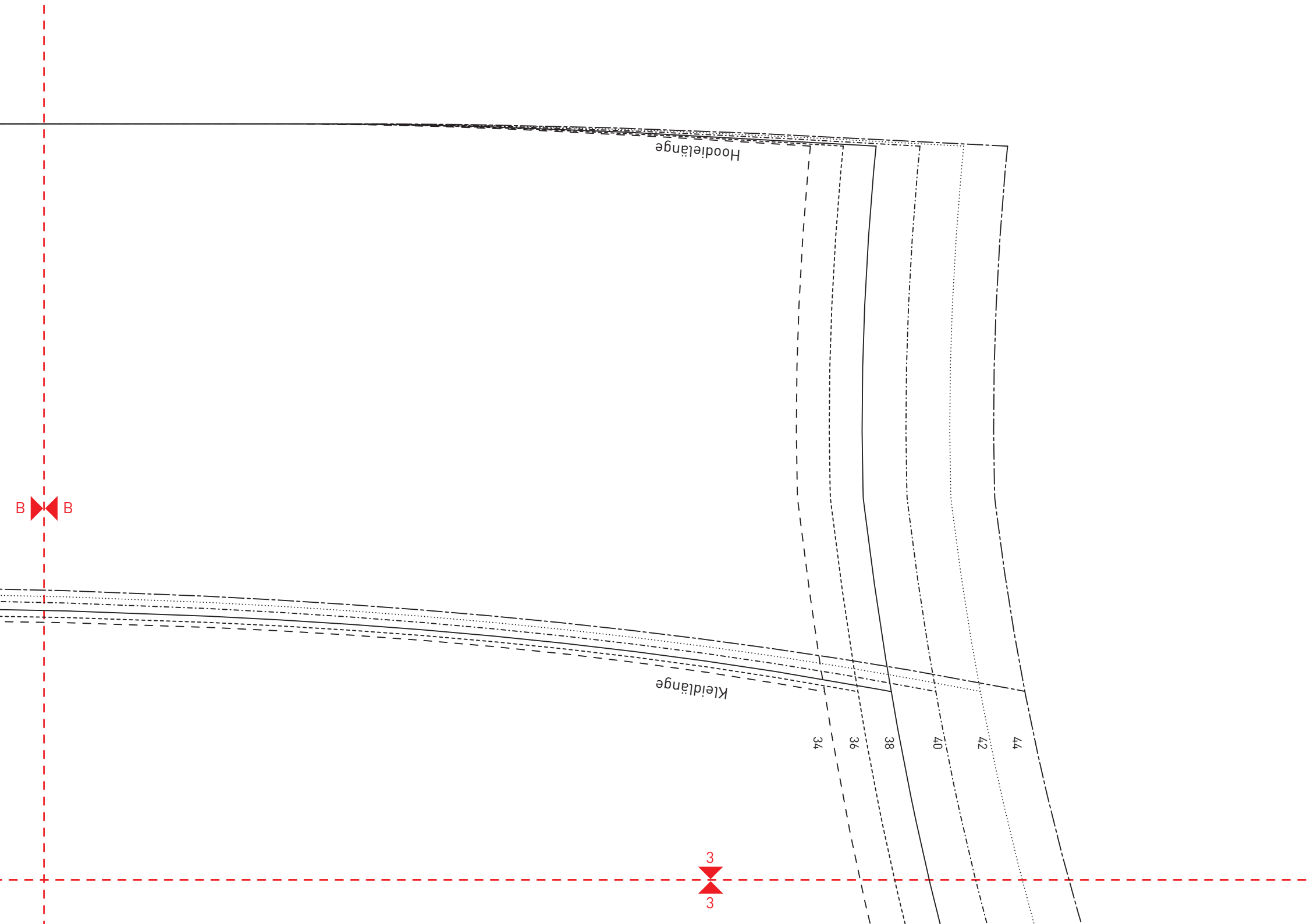

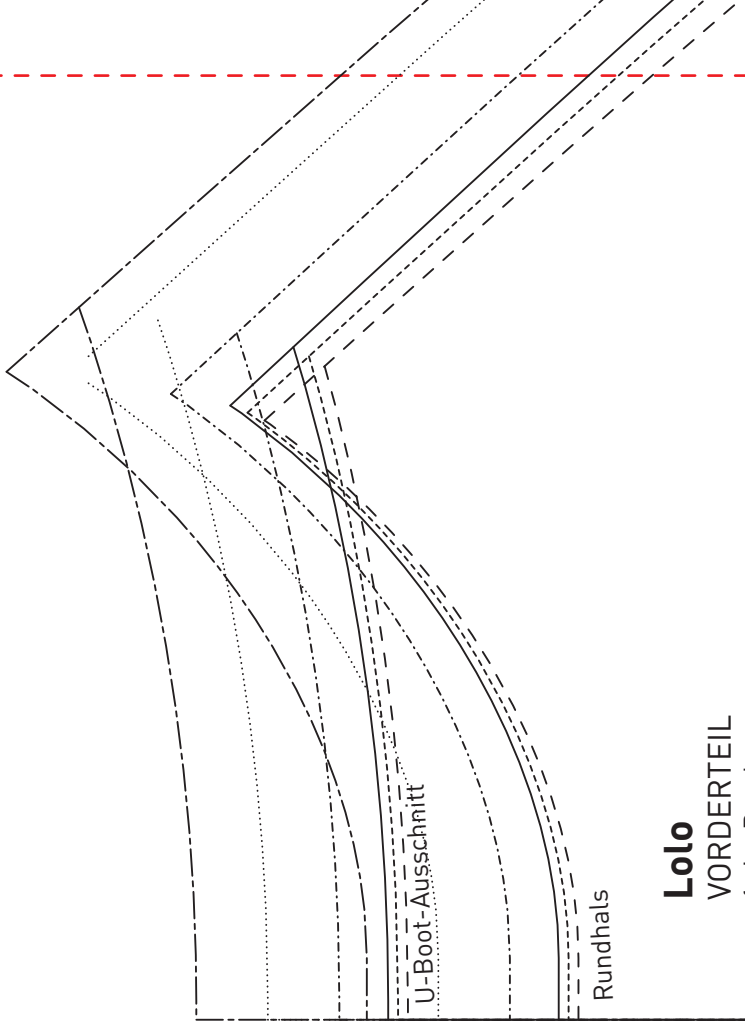

Lolo
VORDETEIL
1x im Bruch

Rundhals

U-Boot-Ausschnitt

VM/Bruch/Fadenlauf

1
1

C C

4
4

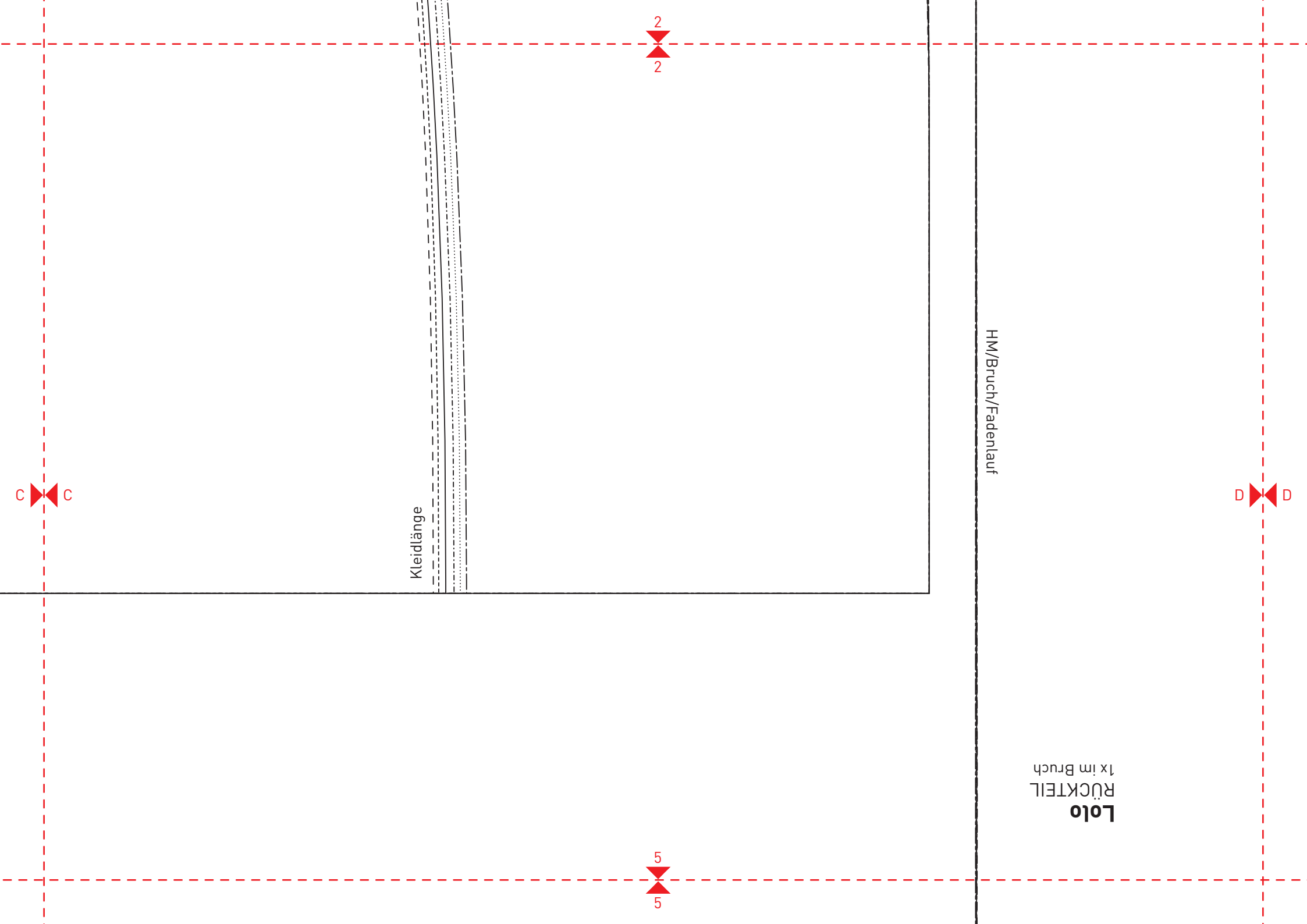

Lolo
RÜCKTEIL
1x im Bruch

HM/Bruch/Fadenlauf

Kleidlänge

2

2

5

5

C

C

D

D

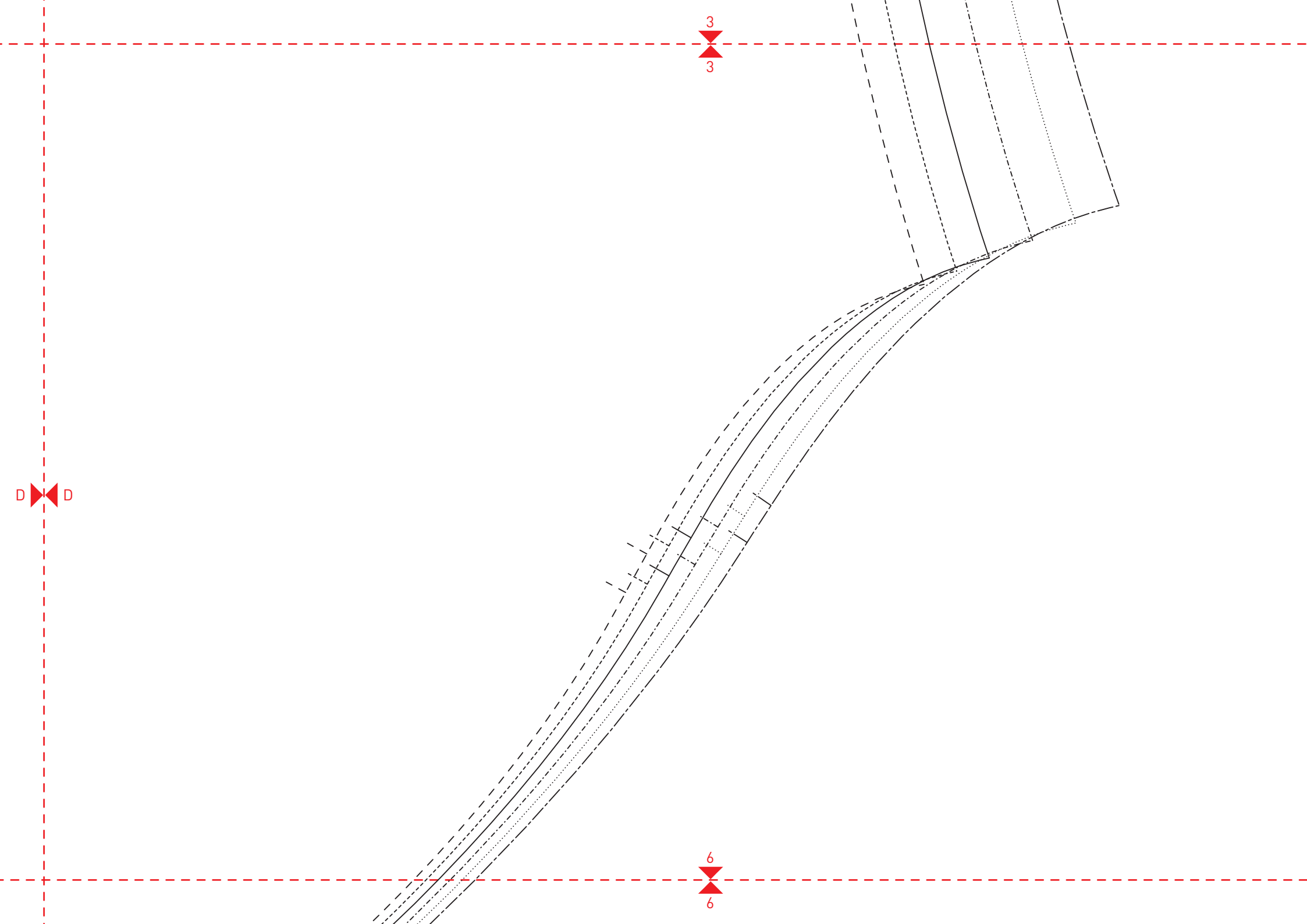

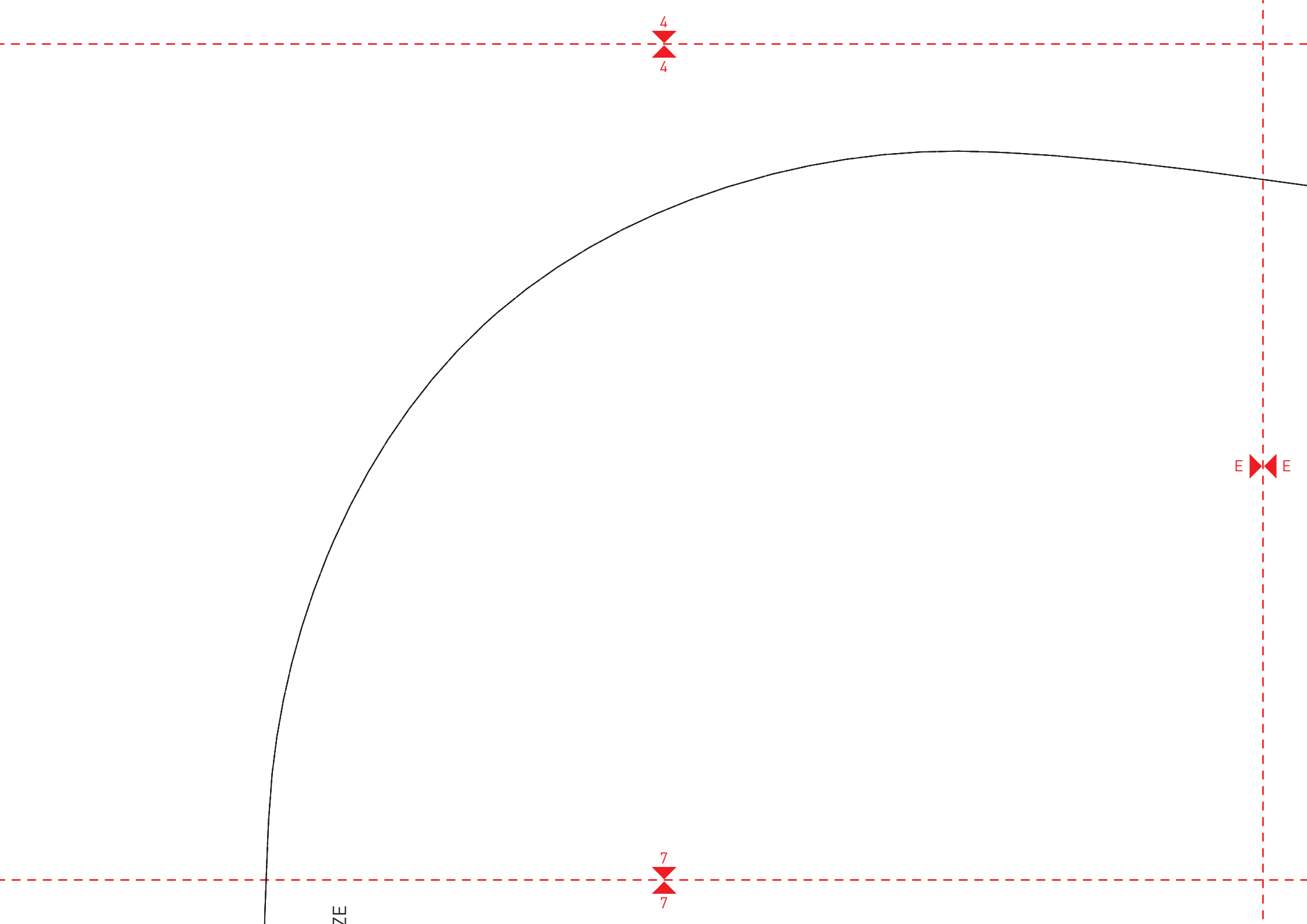

4
4

E E

7
7

ZE

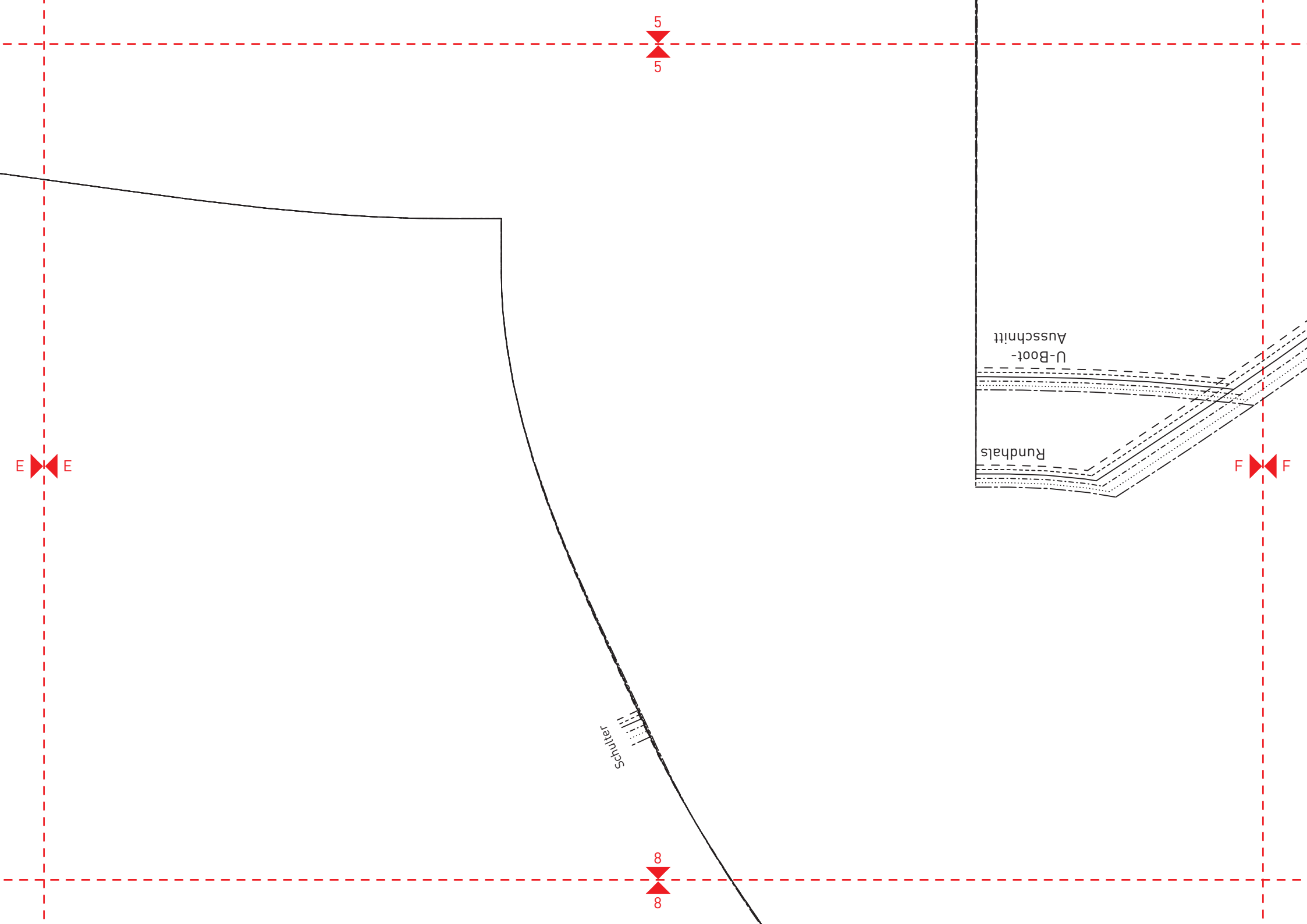

E E

5
5

Schliff

8
8

U-Boot-
Ausschnitt

Rundhals

F F

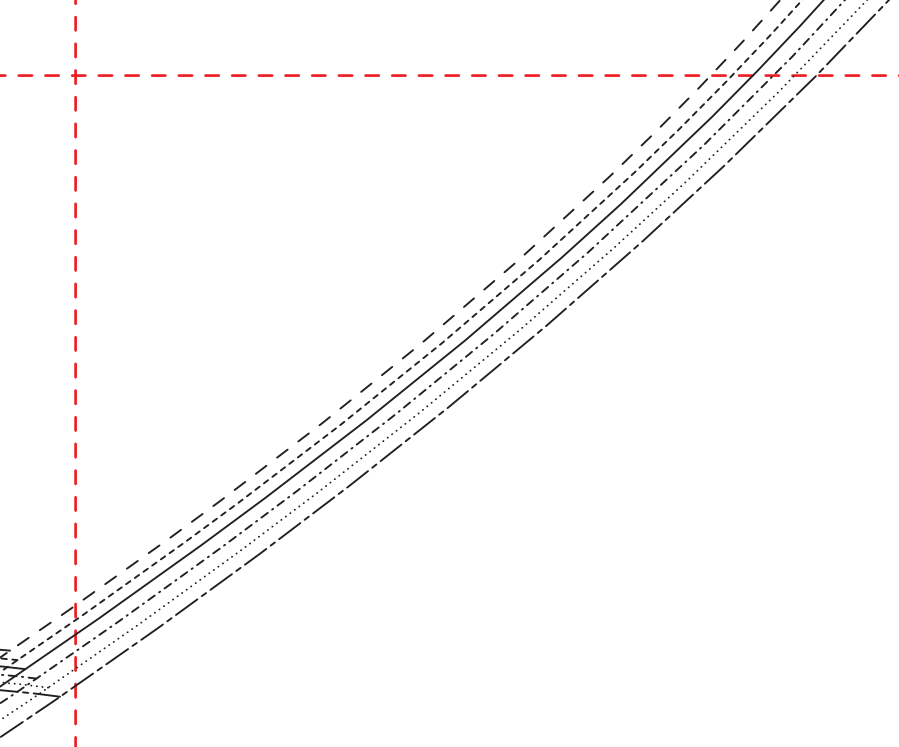

F

6

77
72
70
38
36
34

Lolo
SAUMBUND
1x im Bruch

9

Lolo
KAPUZE
4x

Fadenlauf →

7
7

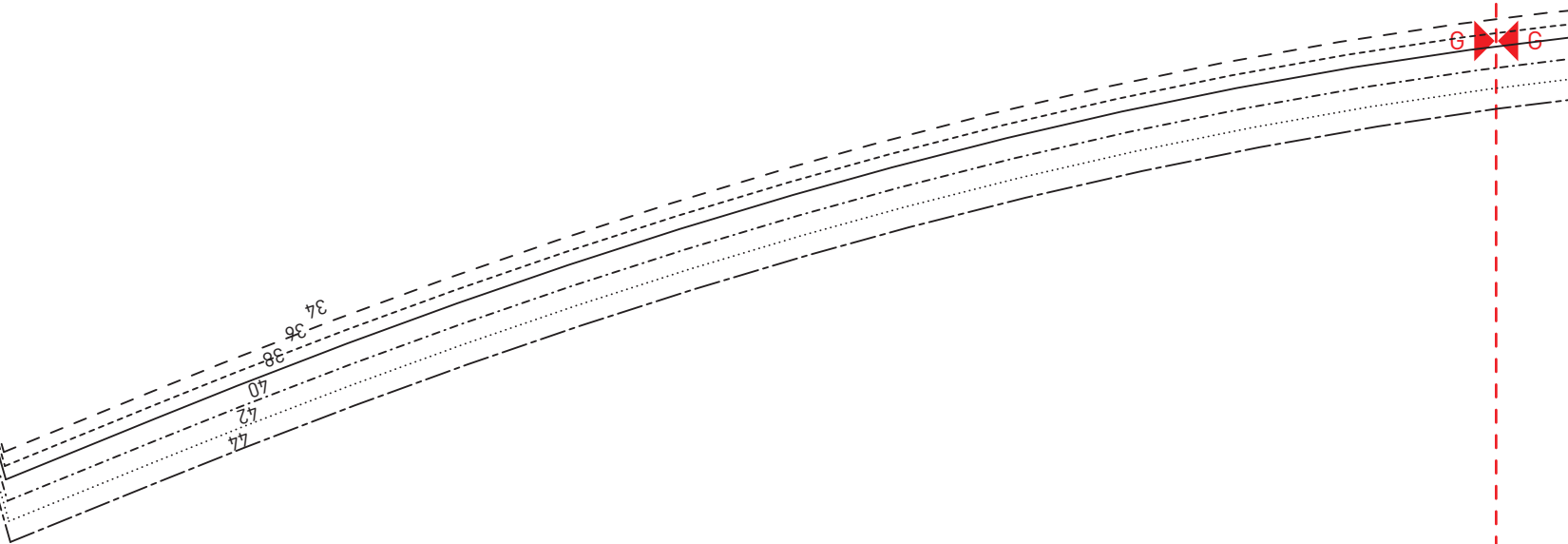

10
10

6
6

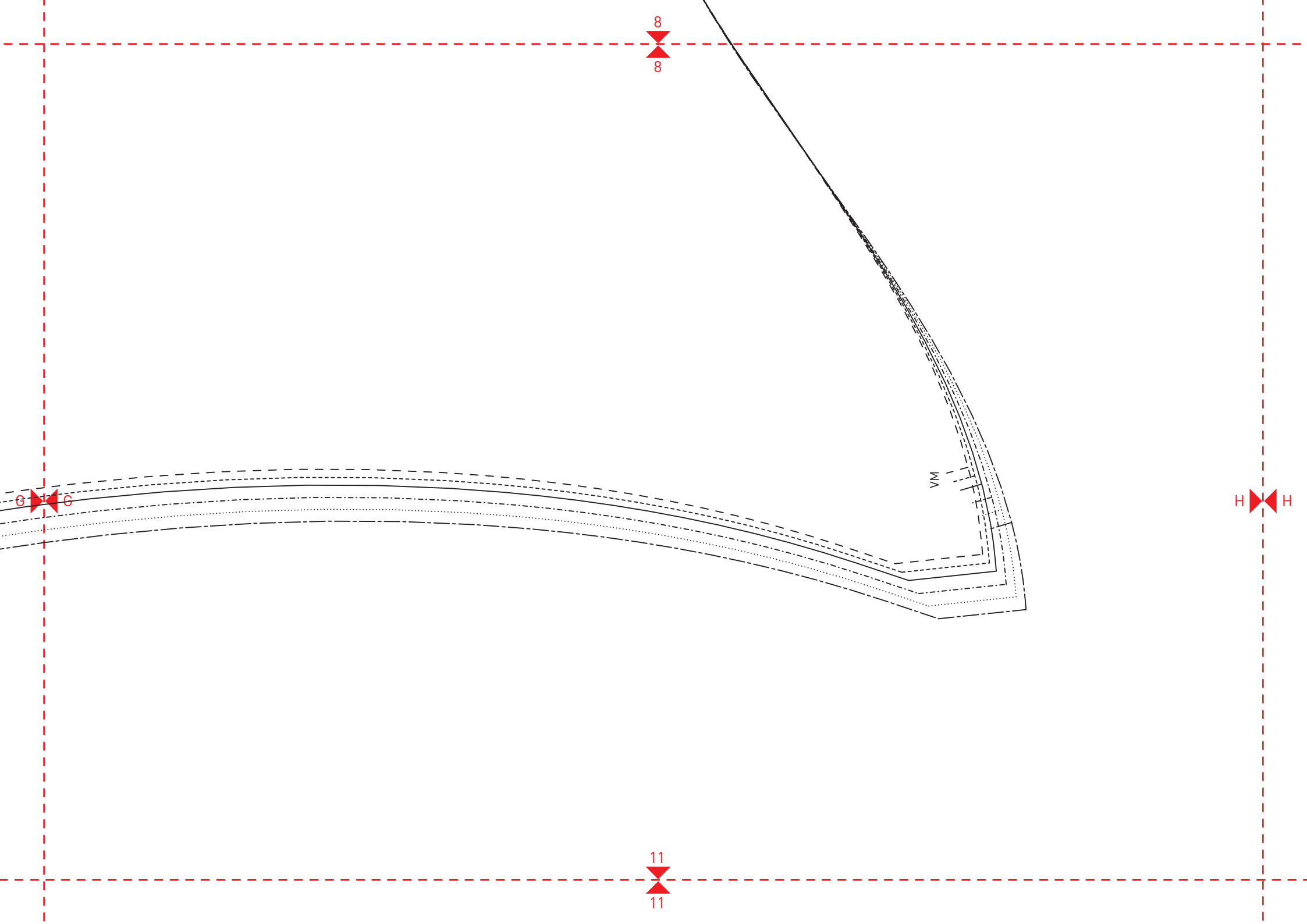



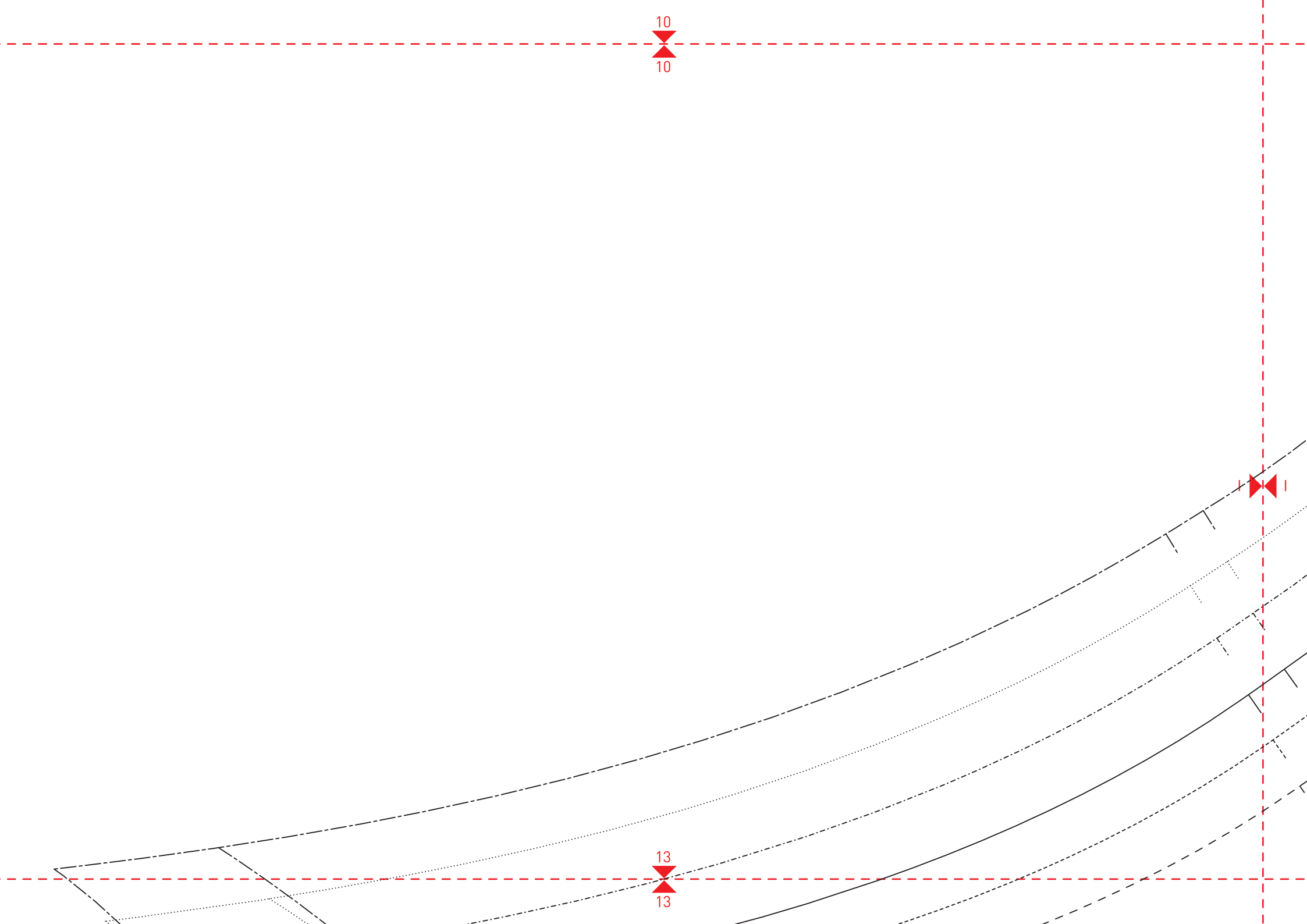

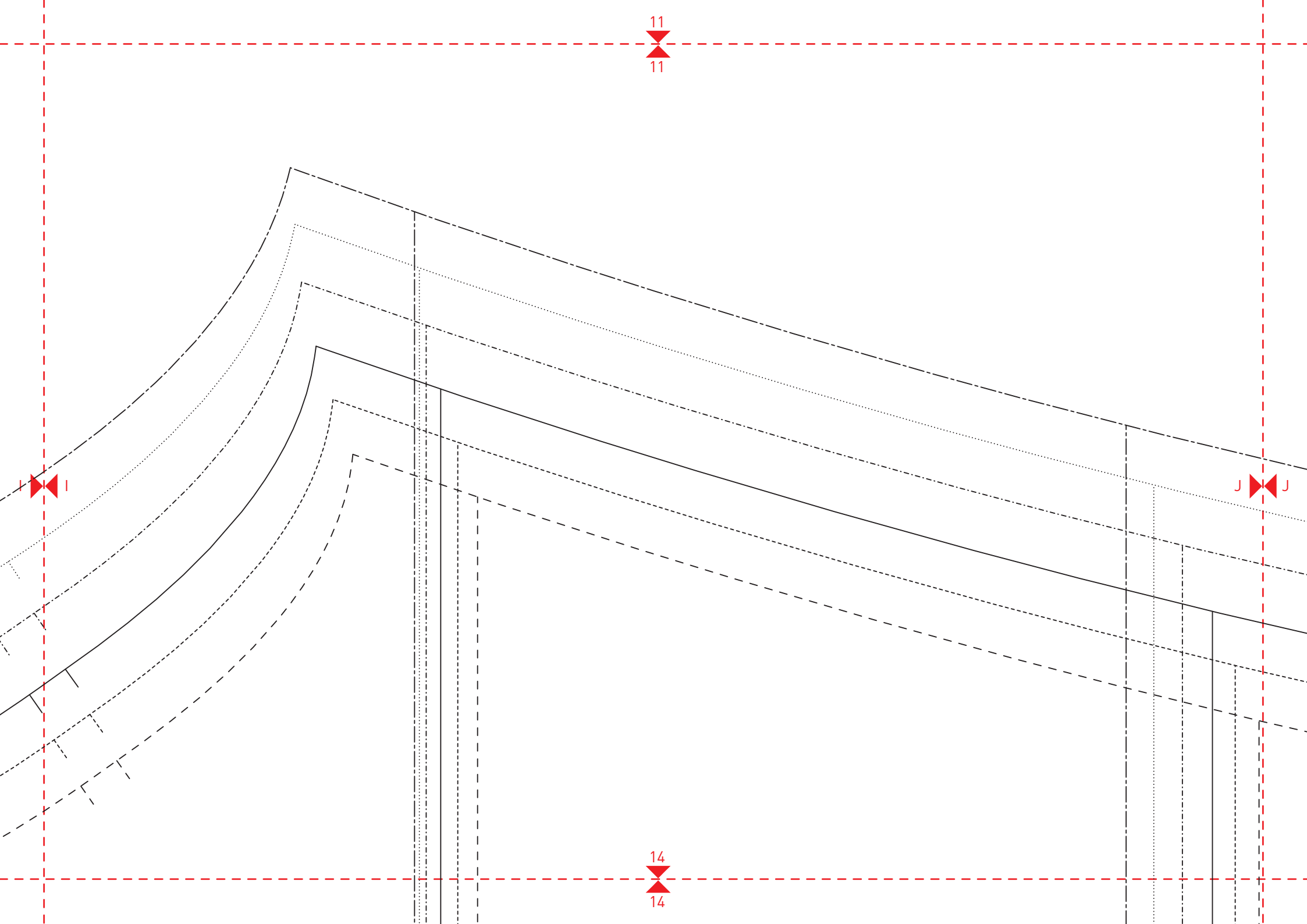

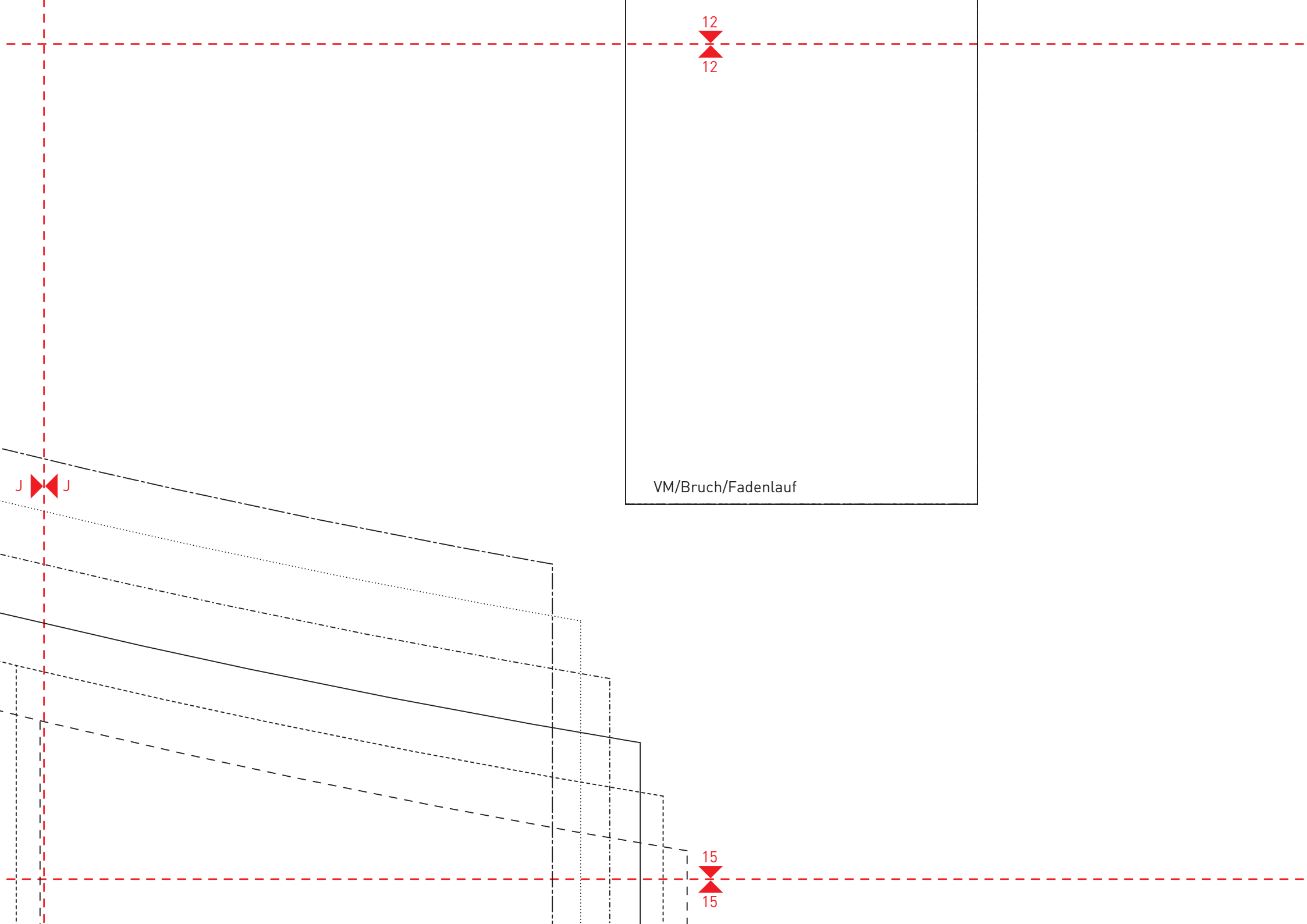

12
12

J J

VM/Bruch/Fadenlauf

15
15

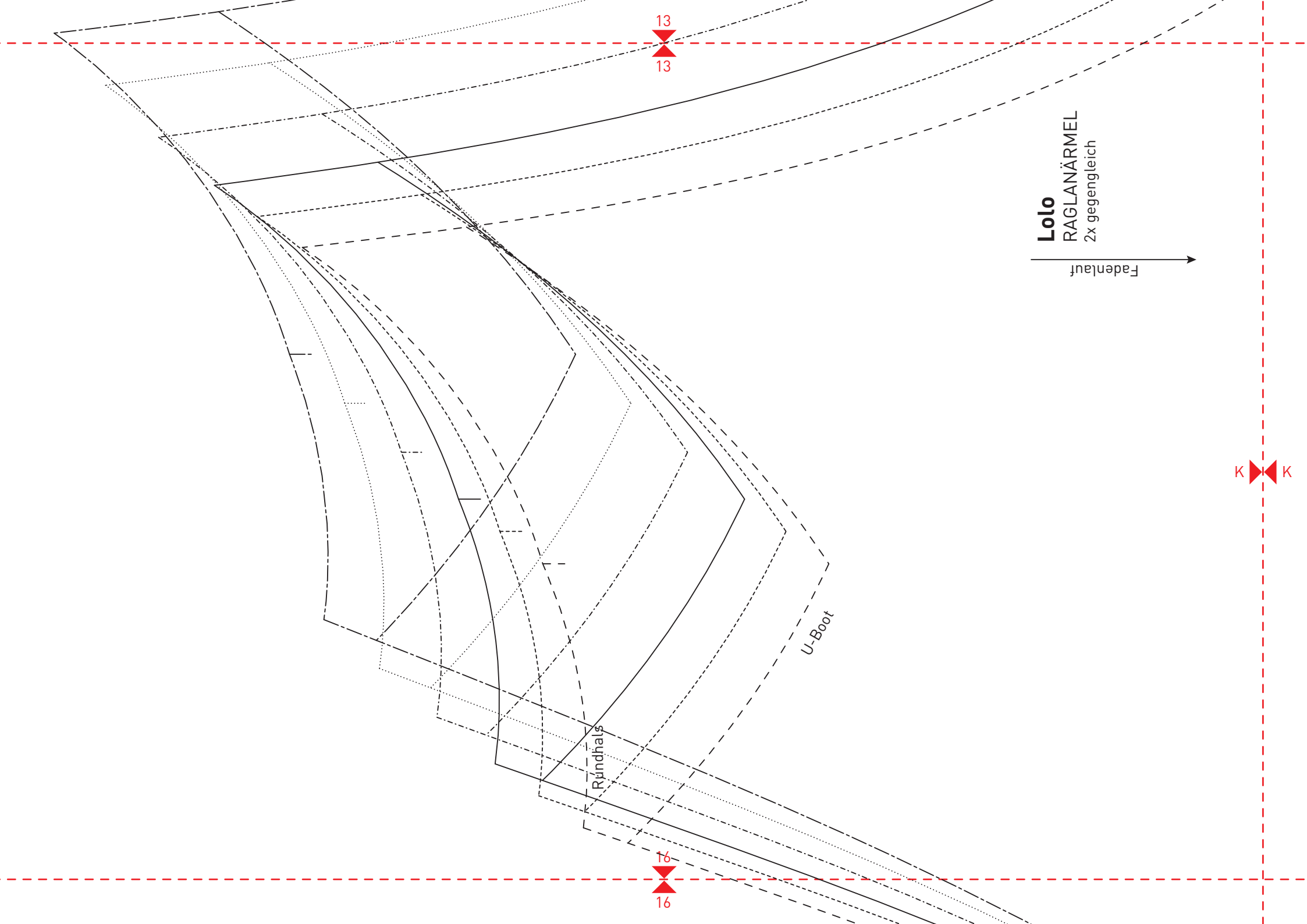

13
13

Lolo
RAGLANÄRMEL
2x gegengleich
Fadenlauf →

K ← K

16
16

U-Boot

Ründhals

