

Schnittbogen Pannentasche Avería

Kontrollquadrat
5cm x 5cm

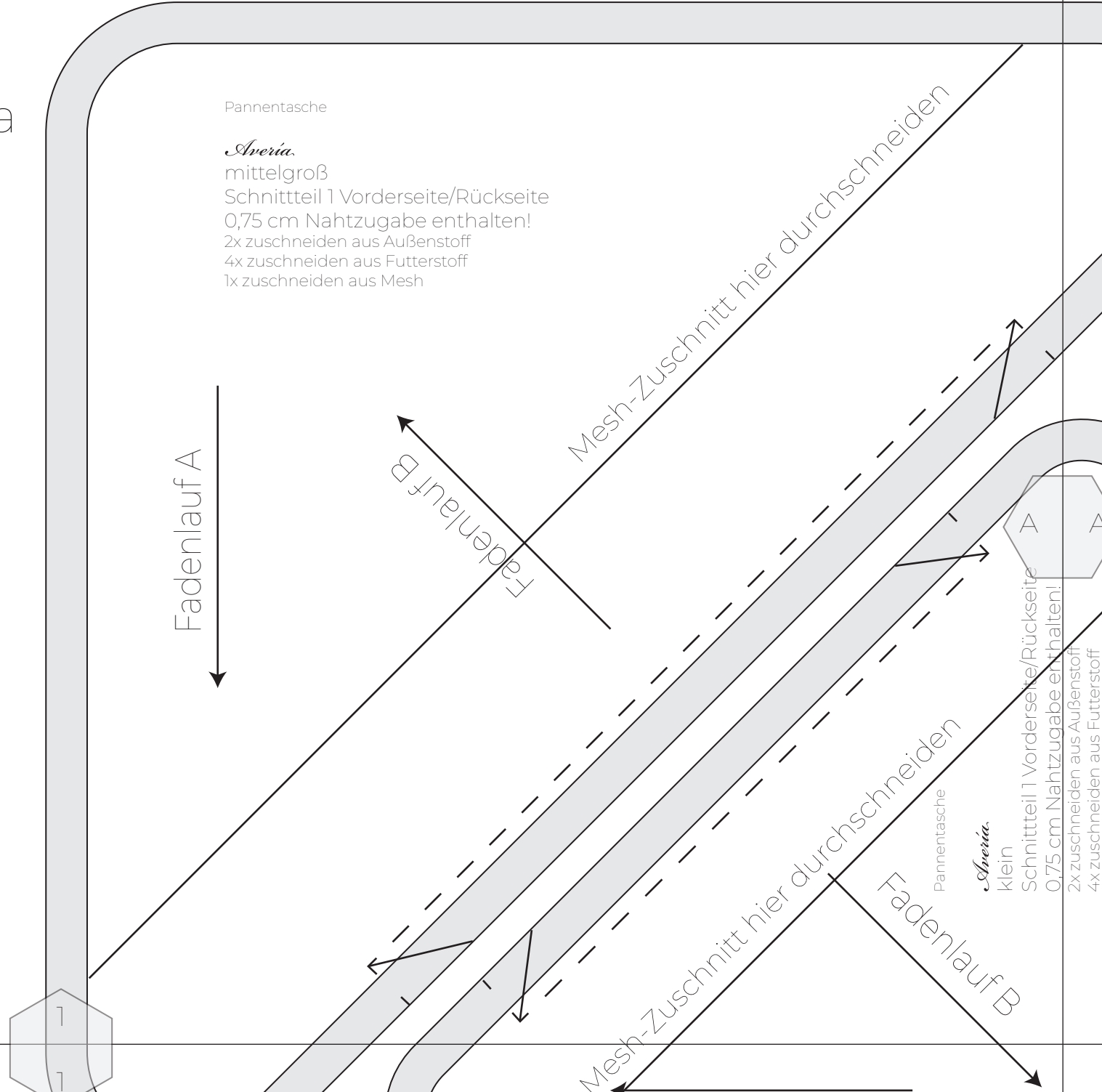

Schnittteil 1 Vorderseite/Rückseite
0,75 cm Nahtzugabe enthalten!
2x zuschneiden aus Außenstoff
4x zuschneiden aus Futterstoff
1x zuschneiden aus Mesh

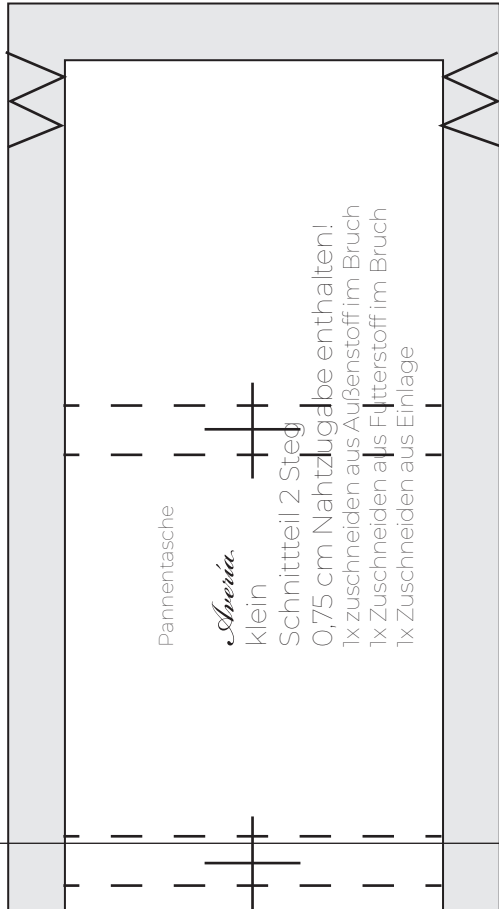
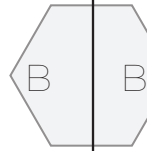
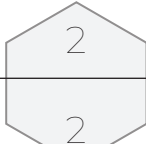
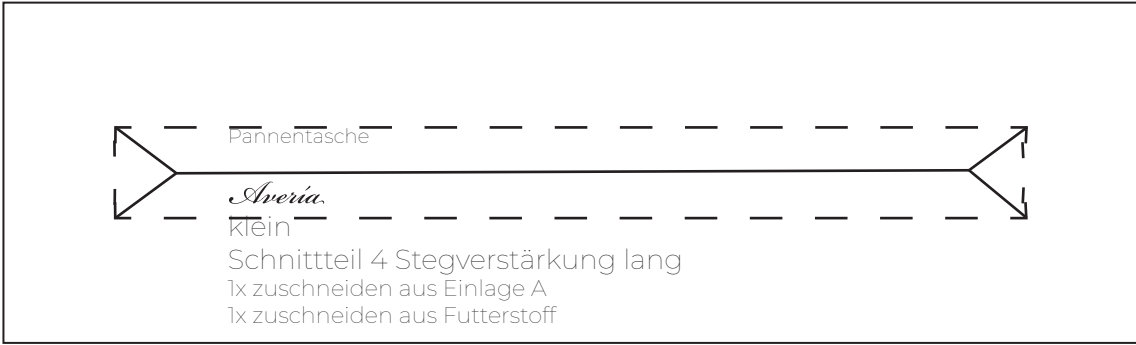
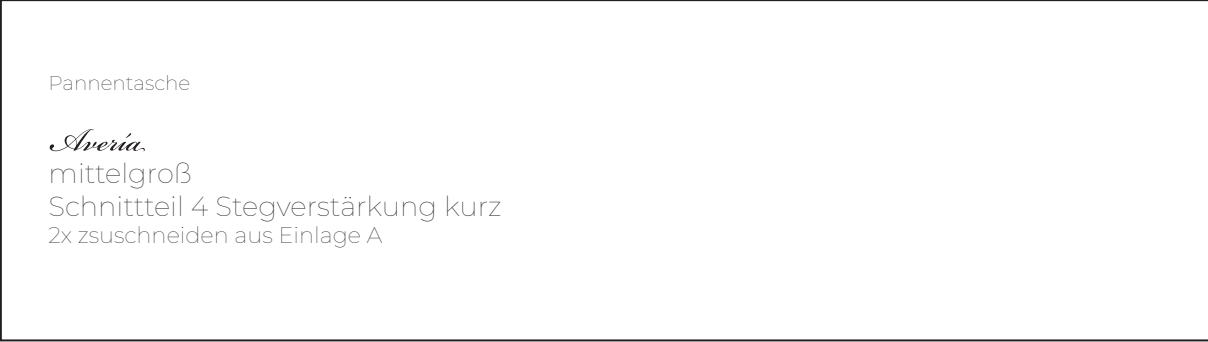
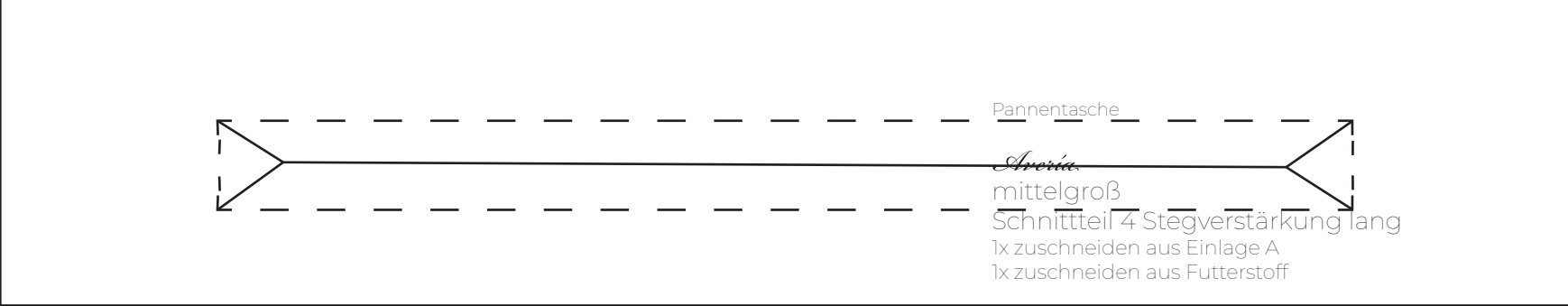

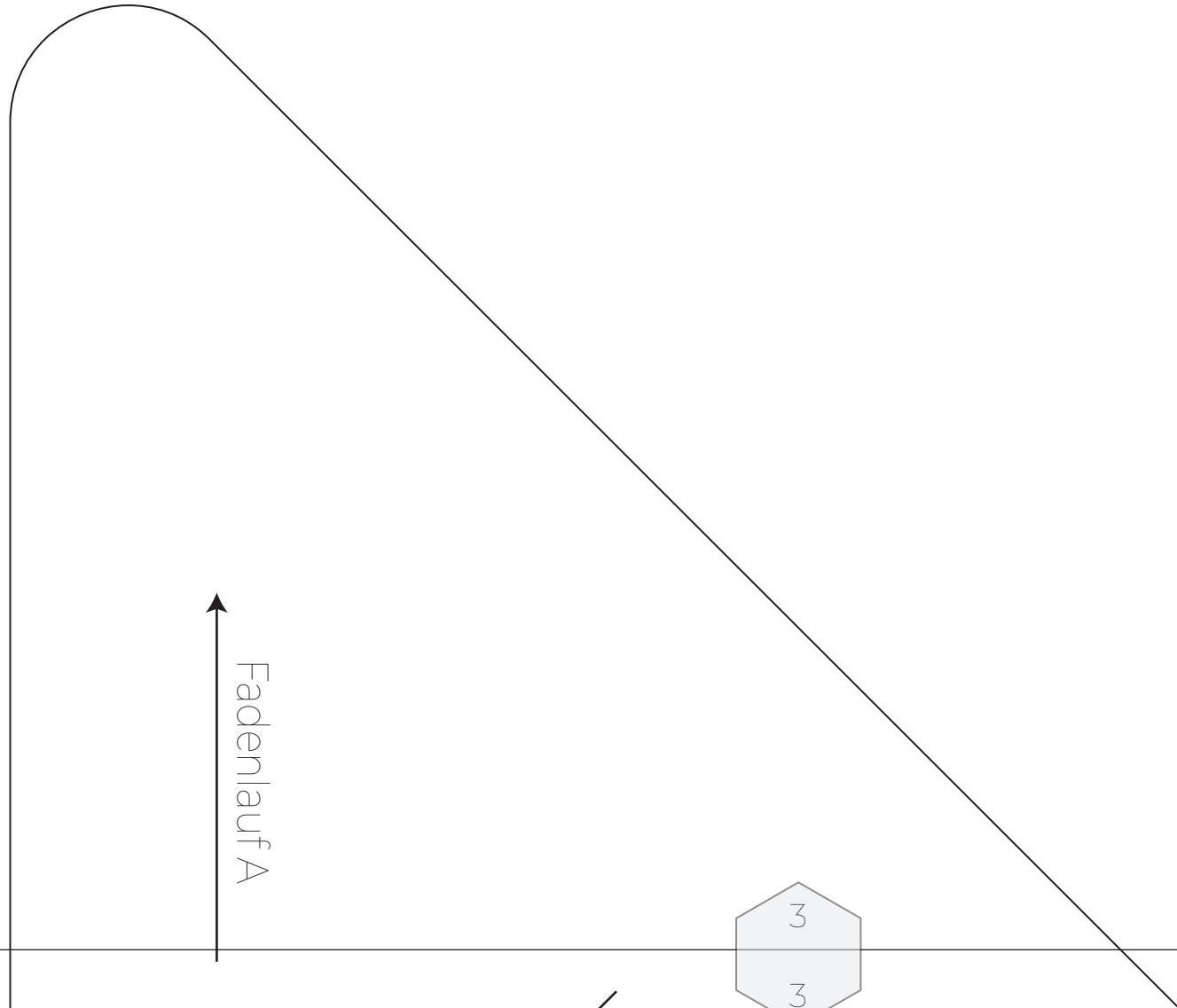
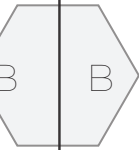

Fadenlauf A

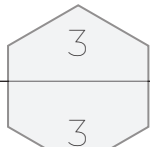

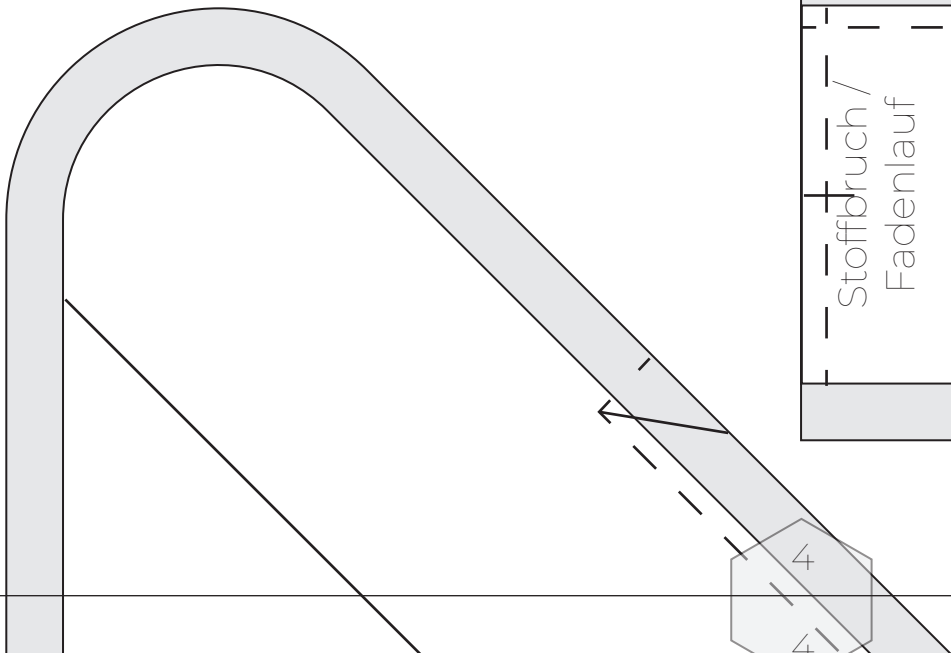
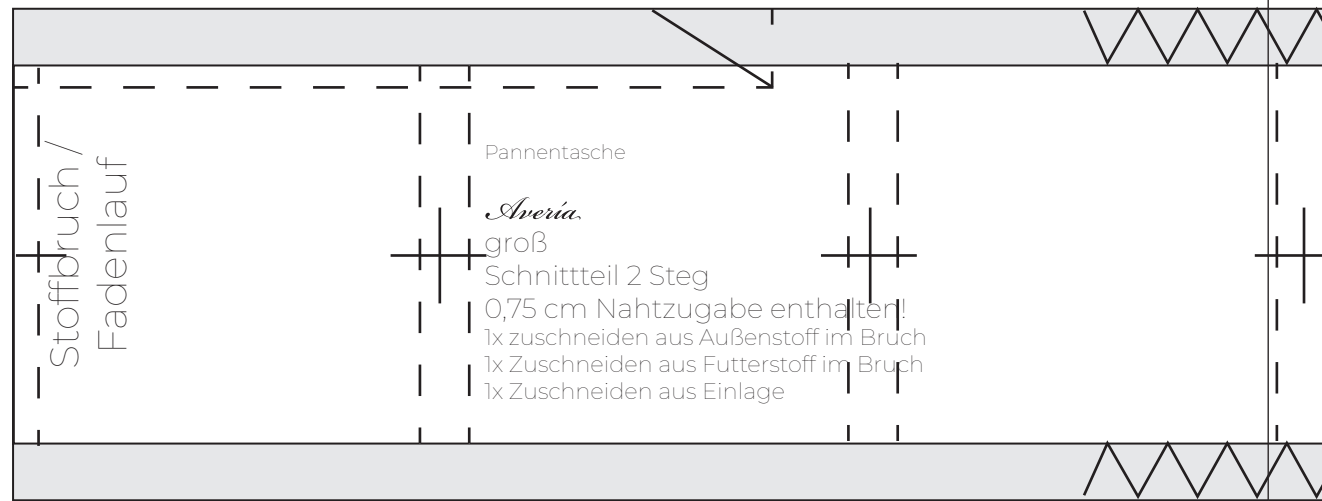
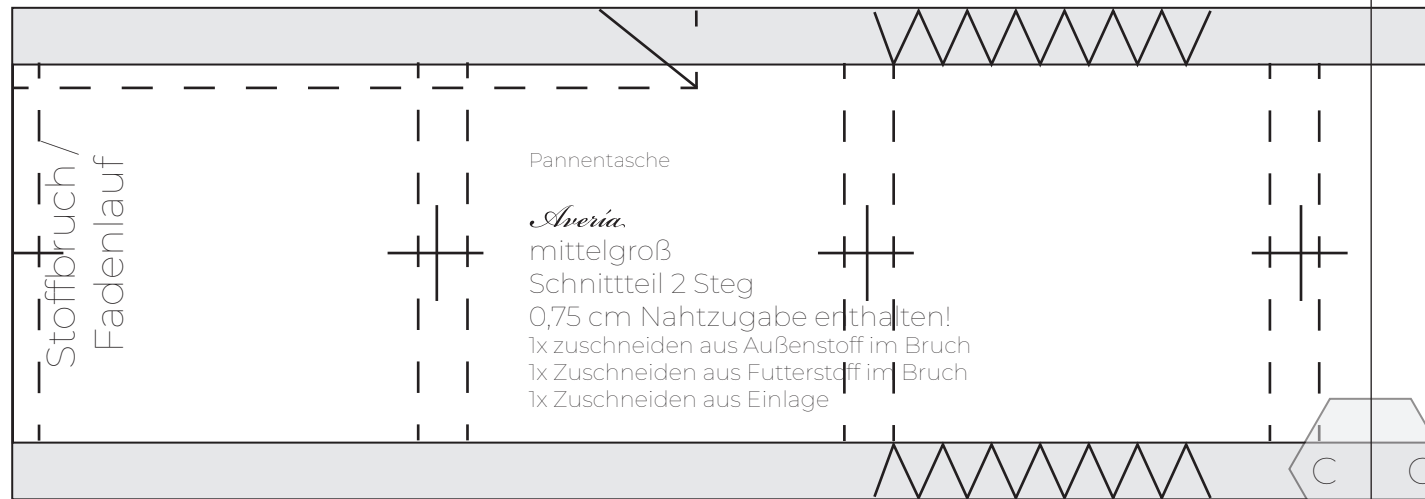
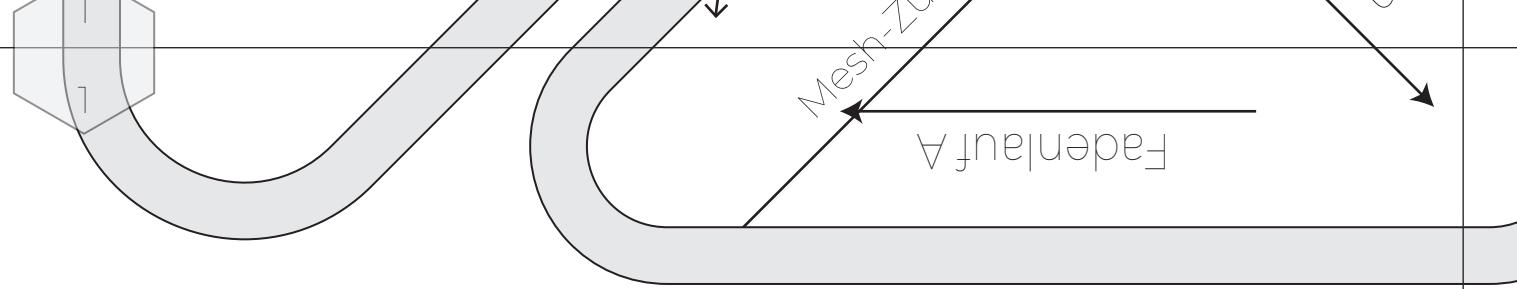
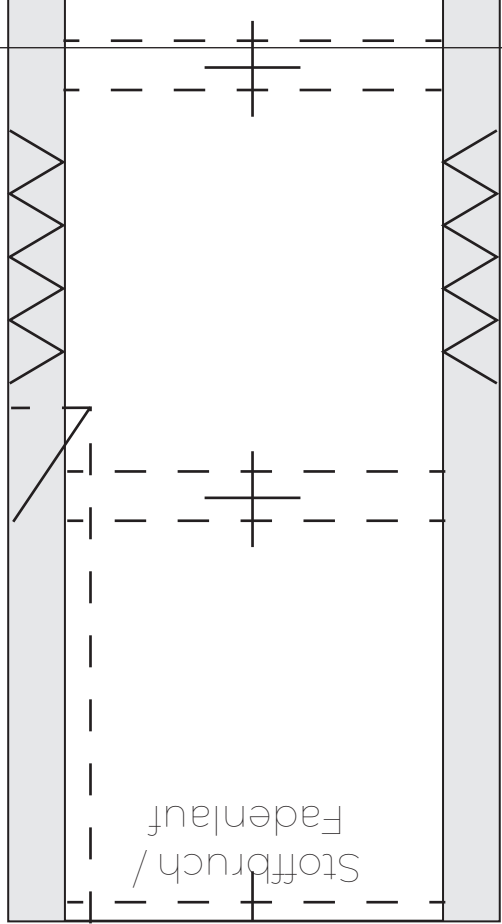

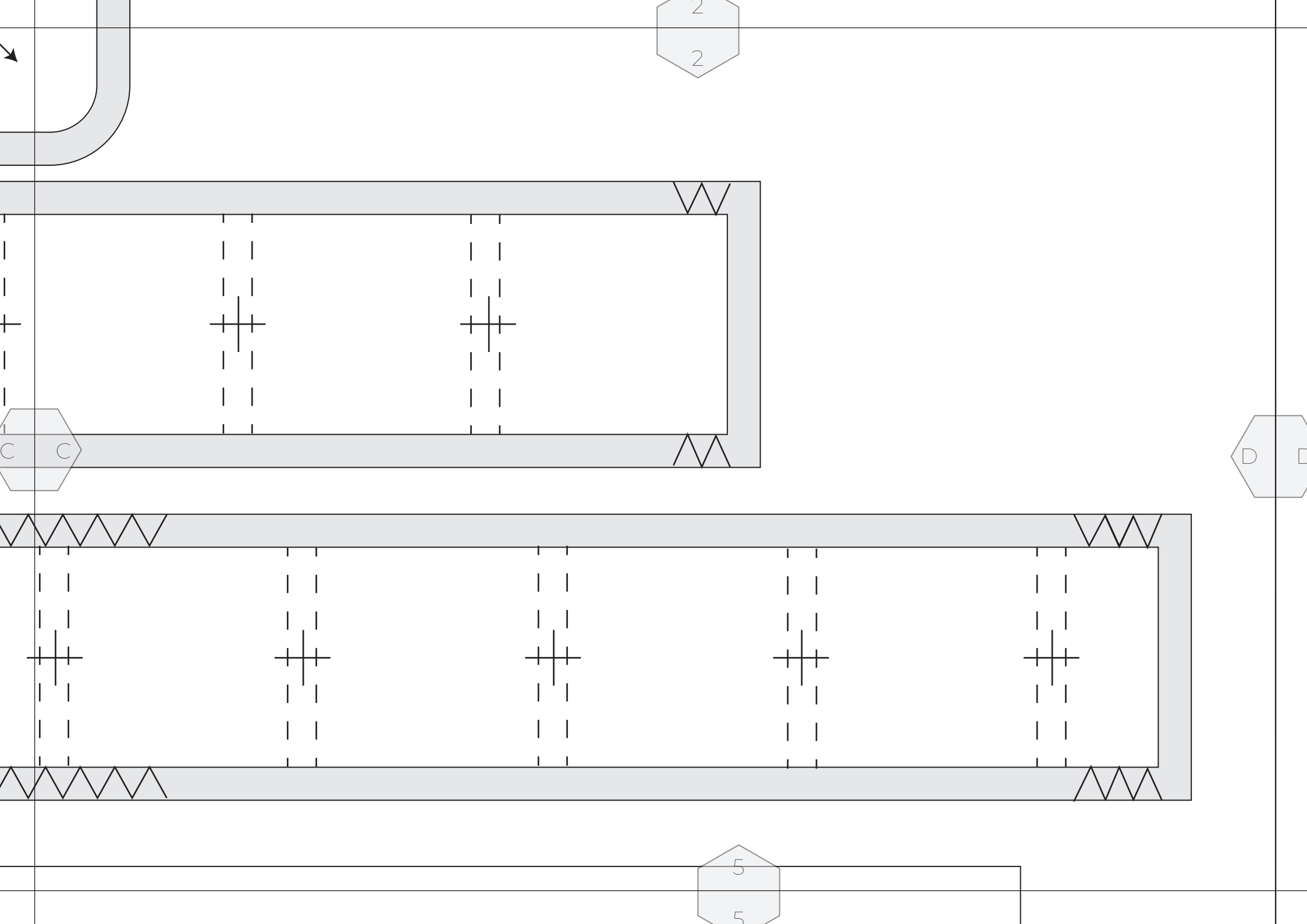

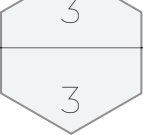

Fadenlauf B

Pannentasche

Averia.
groß
Schnittteil 5 Verstärkung
2x zuschneiden aus Einlage A

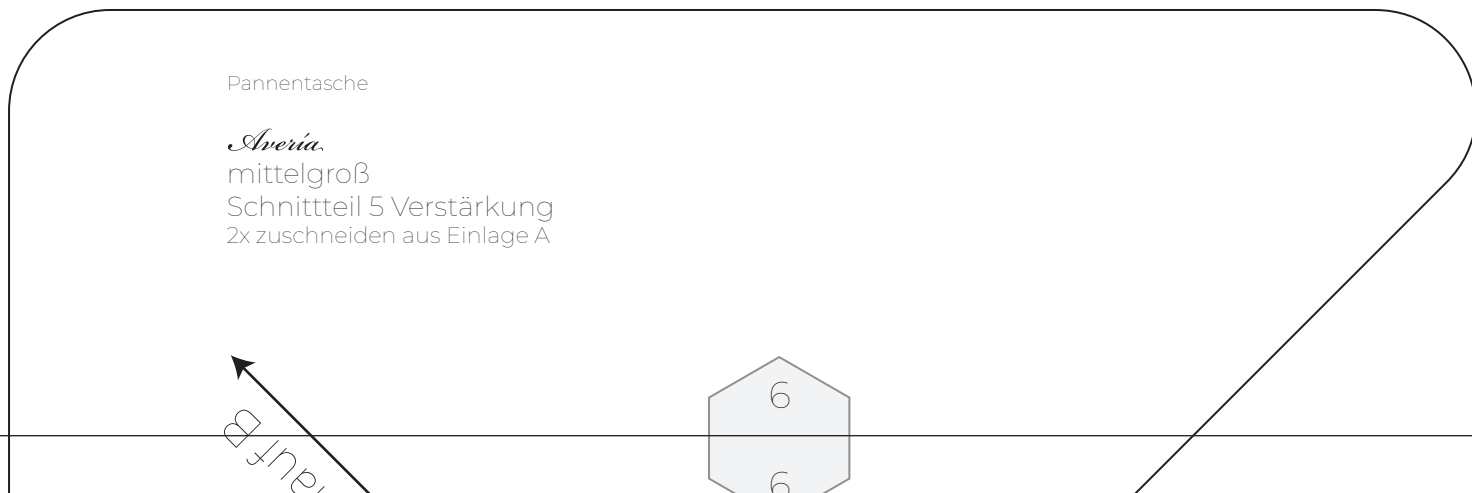
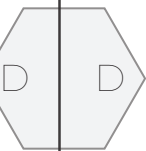

Pannentasche

Averia.
mittelgroß
Schnittteil 5 Verstärkung
2x zuschneiden aus Einlage A

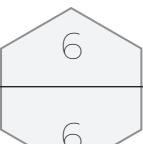

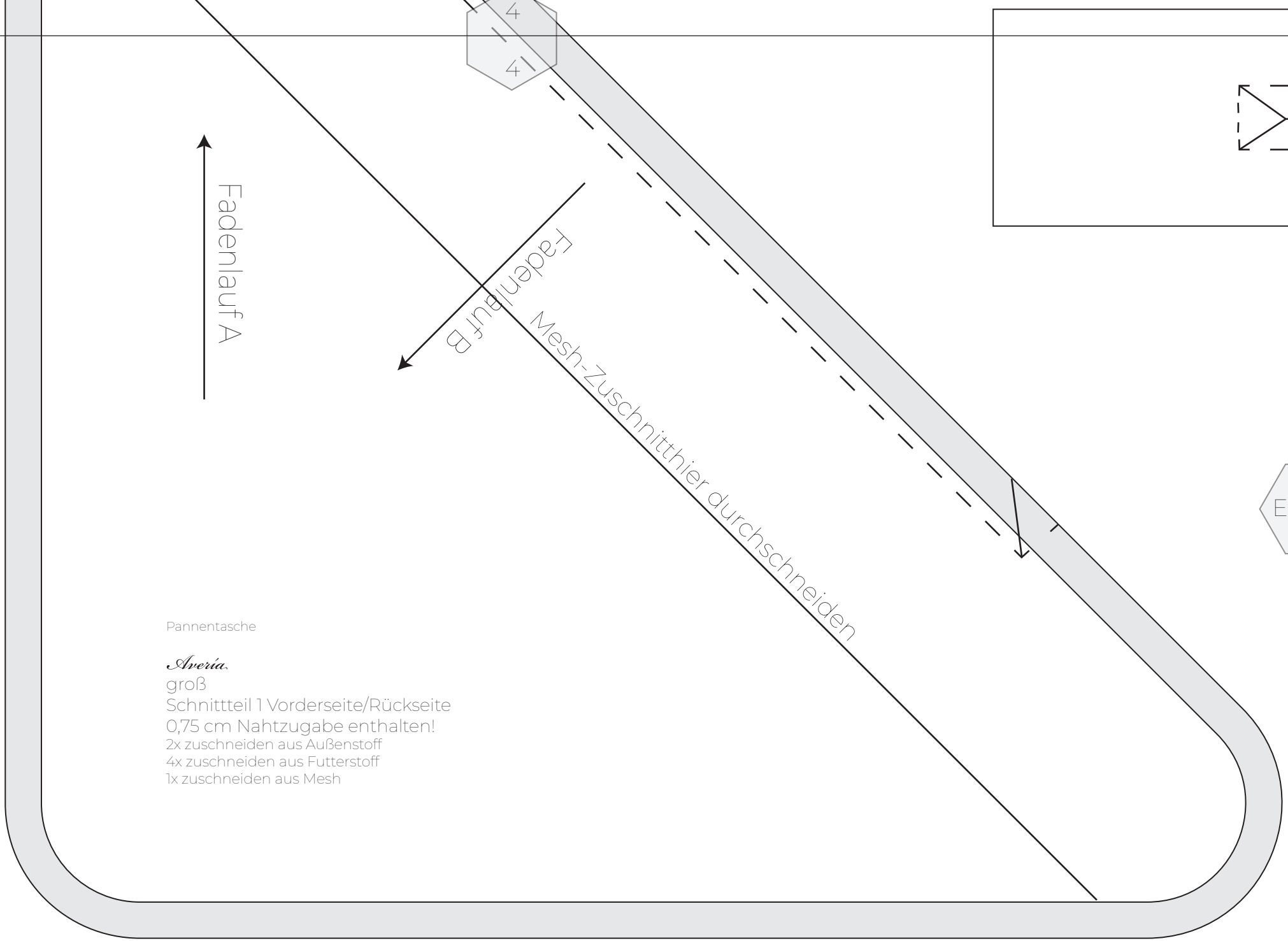

Pannentasche

Averia.

groß

Schnittteil 1 Vorderseite/Rückseite

0,75 cm Nahtzugabe enthalten!

2x zuschneiden aus Außenstoff

4x zuschneiden aus Futterstoff

1x zuschneiden aus Mesh

Pa
g
S
2x

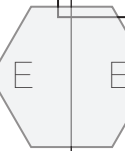

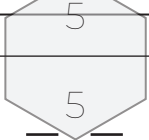

Pannentasche

Averia
groß

Schnittteil 3 Stegverstärkung lang
1x zuschneiden aus Einlage A
1x zuschneiden aus Futterstoff

Pannentasche

Averia
groß

Schnittteil 3 Stegverstärkung kurz
2x zuschneiden aus Einlage A

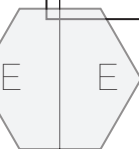

Pannentasche

Averia
Klein Schnittteil 3 Stegverstärkung kurz
2x zuschneiden aus Einlage A

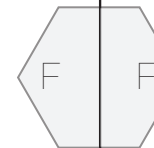

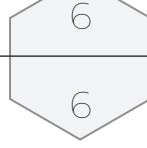
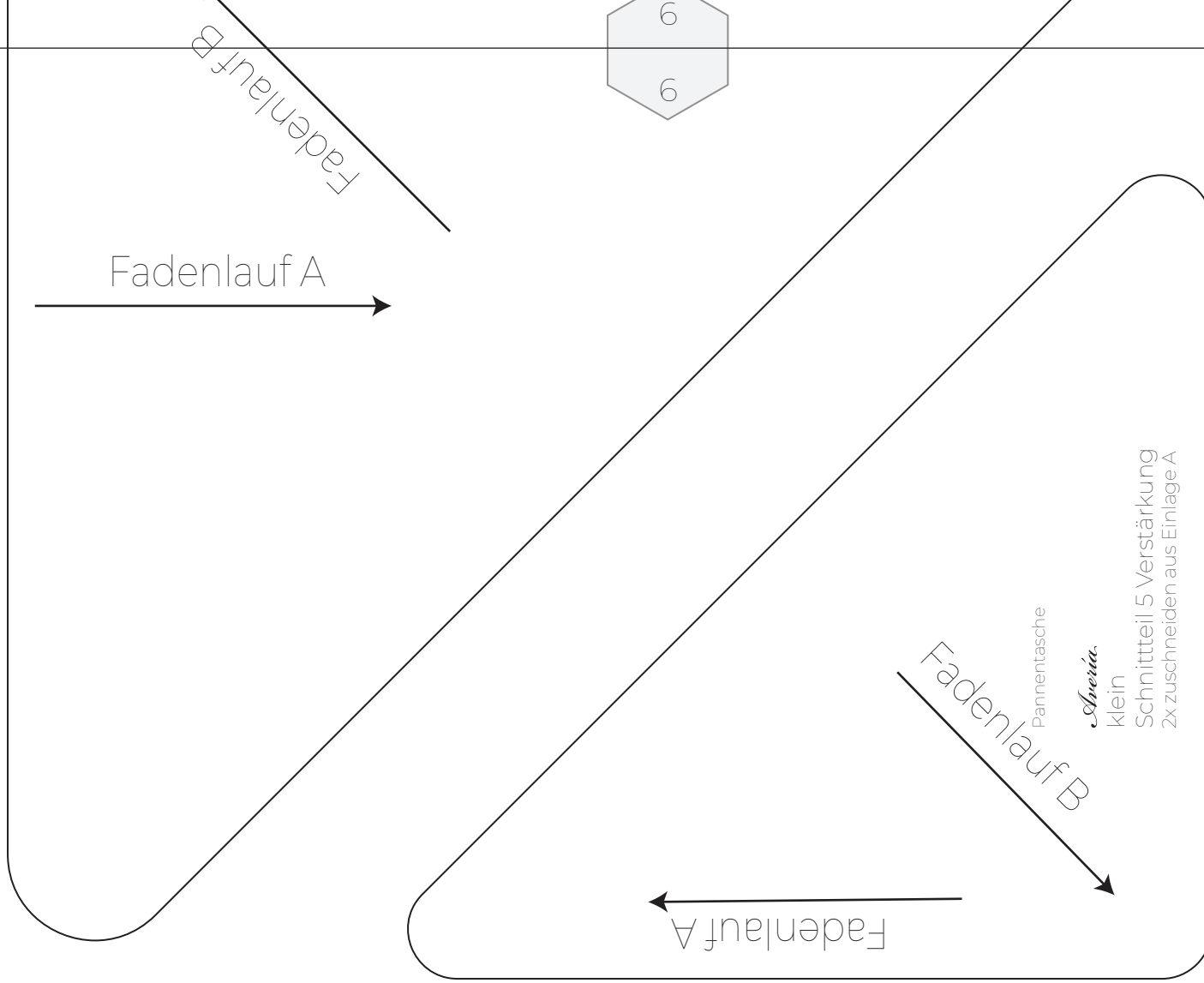
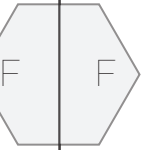

kleines RV-Fach
14 cm RV klein
18 cm RV Medium
20 cm RV groß